

# Rinieri



MADE IN

ITALY



-  PULIZIA FOSSI & BORDI STRADALI
-  DITCH & ROADSIDE CLEANING
-  NETTOYAGE FOSSÉS & BORDS ROUTIERS
-  REINIGUNG VON GRÄBEN & STRASSENRÄNDERN
-  LIMPIEZA CUNETAS & BORDES DE CARRETERAS

MADE IN ITALY SINCE 1920

[www.rinieri.com](http://www.rinieri.com)

# TRS - TRS-E

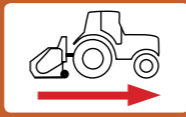

# TRSM - TRSM-E

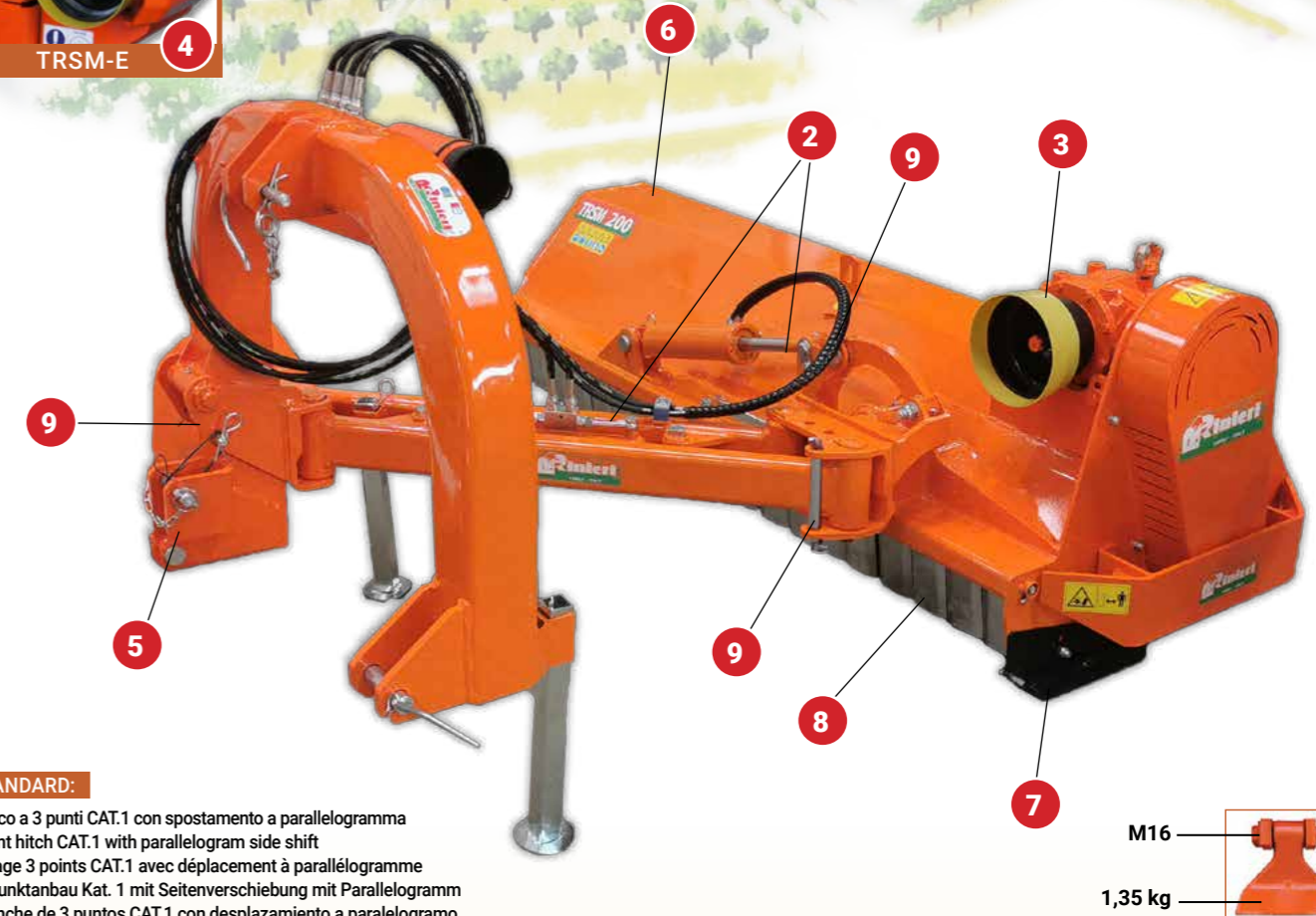
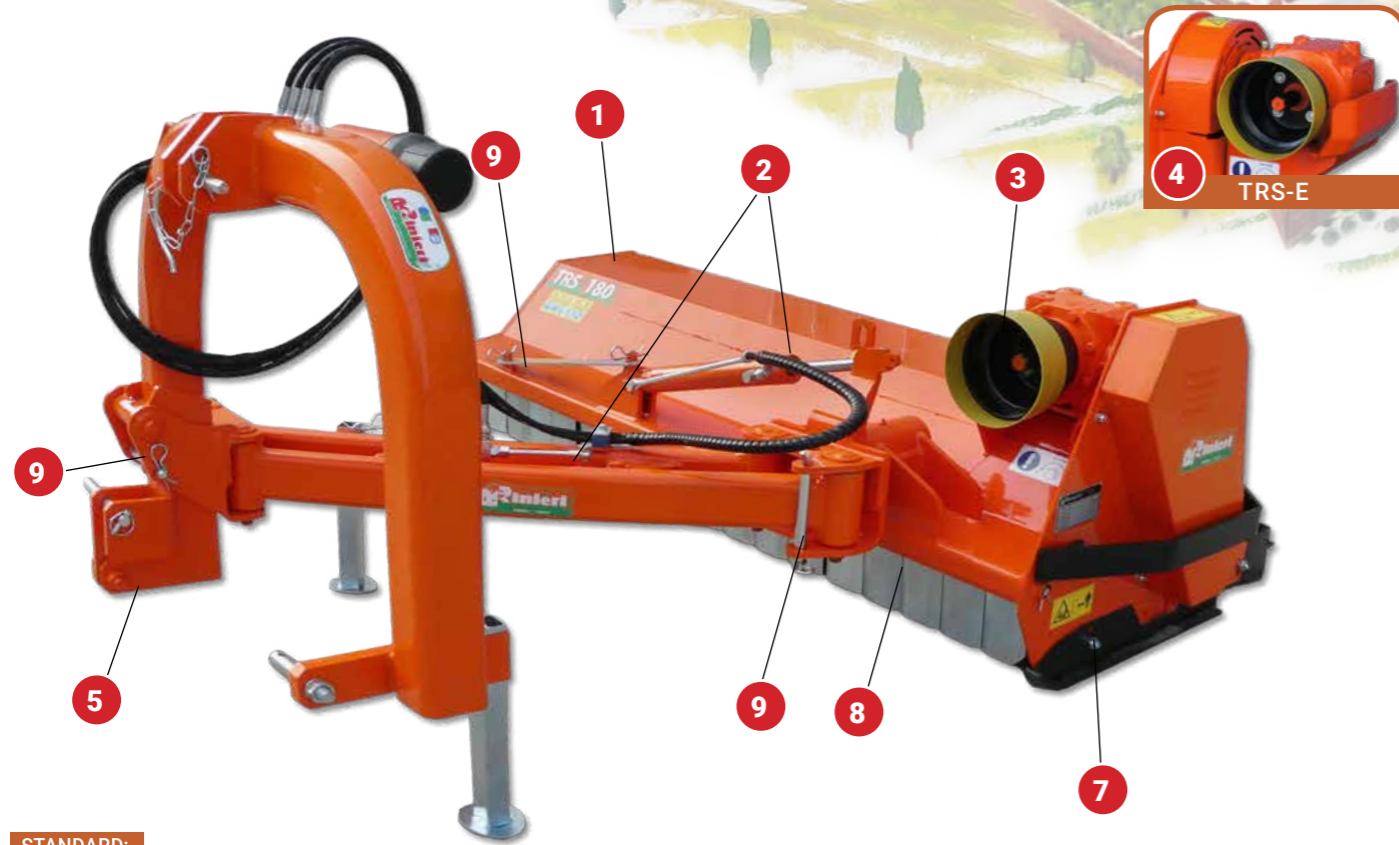
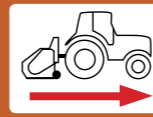

**STANDARD:**

Attacco a 3 punti CAT.1 con spostamento a parallelogramma  
 3-point hitch CAT.1 with parallelogram side shift  
 Attelage 3 points CAT.1 avec déplacement à parallélogramme  
 Dreipunktbau Kat. 1 mit Seitenverschiebung mit Parallelogramm  
 Enganche de 3 puntos CAT.1 con desplazamiento a paralelogramo



**STANDARD:**

Attacco a 3 punti CAT.1 con spostamento a parallelogramma  
 3-point hitch CAT.1 with parallelogram side shift  
 Attelage 3 points CAT.1 avec déplacement à parallélogramme  
 Dreipunktbau Kat. 1 mit Seitenverschiebung mit Parallelogramm  
 Enganche de 3 puntos CAT.1 con desplazamiento a paralelogramo



**TRS TRINCIATUTTO SPOSTABILE - VERGE MOWER - BROYEUR LATERAL - BÖSCHUNGSMULCHER - TRITURADORA LATERAL**

MOD.	N°	Hp	cm (inch)	cm (inch)	Kg (lb)	N°
TRS / TRS-E 130	28 - 14	30 - 40	130 (51")	140 (55") / 170 (66")	430 (947) / 460 (1014)	3
TRS / TRS-E 150	32 - 16	40 - 50	150 (59")	160 (63") / 190 (74")	460 (1014) / 490 (1080)	3
TRS / TRS-E 165	36 - 18	50 - 60	165 (65")	175 (68") / 205 (80")	490 (1080) / 520 (1146)	3
TRS / TRS-E 180	40 - 20	50 - 60	180 (71")	190 (74") / 220 (86")	520 (1146) / 550 (1212)	3

**TRSM TRINCIATUTTO SPOSTABILE - VERGE MOWER - BROYEUR LATERAL - BÖSCHUNGSMULCHER - TRITURADORA LATERAL**

MOD.	N°	Hp	cm (inch)	cm (inch)	Kg (lb)	N°
TRSM / TRSM-E 185	20	70 - 100	185 (72")	205 (80") / 235 (92")	720 (1587) / 830 (1829)	4
TRSM / TRSM-E 200	22	90 - 120	200 (78")	220 (86") / 250 (98")	750 (1014) / 860 (1080)	4

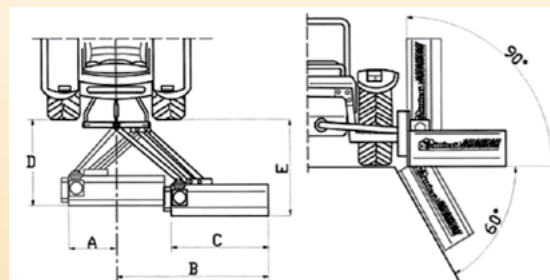

MOD.	A	B	C	D	E
TRS / TRS-E 130	55 / 33	195 / 220	130	200	220
TRS / TRS-E 150	55 / 33	210 / 235	150	200	220
TRS / TRS-E 165	55 / 33	230 / 255	165	200	220
TRS / TRS-E 180	55 / 33	250 / 275	180	200	220

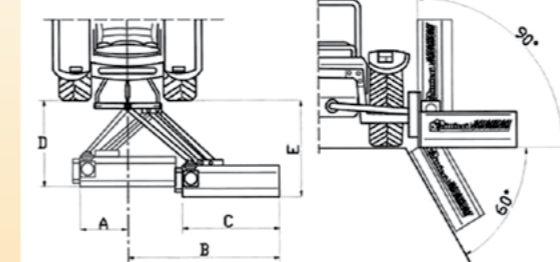

MOD.	A	B	C	D	E
TRSM / TRSM-E 185	58 / 21	255 / 290	185	220	235
TRSM / TRSM-E 200	58 / 21	270 / 305	200	220	235

- 1** Griglia di frantumazione interna  
Interior counter-Knives  
Grille de broyage intérieure  
Filtergitter für bessere Mulchgutzerkleinerung  
Rejilla de trituración interna
- 2** Inclinazione e spostamento idraulici  
Hydraulic shifting and tilting  
Inclination et déplacement hydrauliques  
Hydraulische Verschiebung und Neigung  
Inclinación y desplazamiento hidráulica
- 3** TRS - TRSM  
Moltiplicatore interno alla scocca  
Gearbox inside the frame  
Multiplicateur interne au châssis  
Getriebe an der Innenseite der Außenhülle  
Multiplicador interior al armazón
- 4** TRS-E - TRSM-E  
Moltiplicatore esterno alla scocca  
Gearbox outside the frame  
Multiplicateur externe au châssis  
Getriebe an der Außenseite der Außenhülle  
Multiplicador exterior al armazón
- 5** Snodo antiurto  
Anti-shock system  
Système antichoc  
Anfahrerschutzsystem  
Sistema antichoque
- 6** Doppia scocca con griglia di frantumazione  
Double body with Counter-knives  
Double châssis avec grille de broyage  
Doppelte Außenhülle mit Filtergitter  
Doble armazón con rejilla de trituración
- 7** Slitte laterali regolabili  
Adj. side skids  
Chariot latéral réglables  
Einst. Seitenkufen  
Patines laterales ajustables
- 8** Palette anteriori in acciaio  
Front steel aprons  
Palettes antérieures en acier  
Vordere Sicherheitsklappen aus Stahl  
Paletas anteriores de acero
- 9** Fermi per il trasporto stradale  
Locking device for road trasport  
Bloquage pour circulation routière  
Blockierungen für Straßenverkehr  
Bloqueo para el transporte por carretera

BRACCI DECESPUGLIATORI - REACH MOWERS - ÉPAREUSES  
BÖSCHUNGSMÄHER - BRAZOS DESBROZADORES





OPTIONAL



6

OPTIONAL

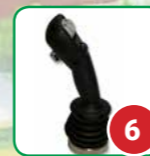

6

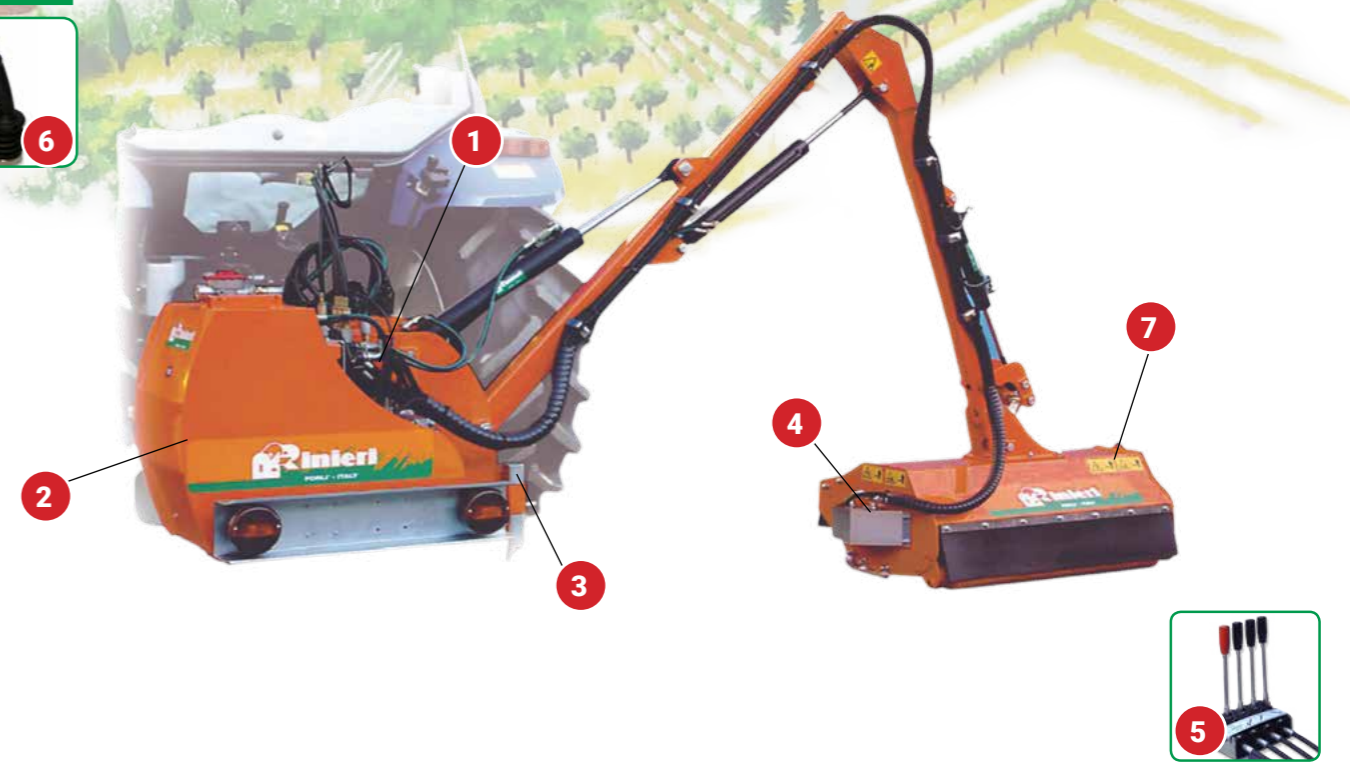

## BRF - BRACCIO DECESPUGLIATORE - REACH MOWER - ÉPAREUSE - BÖSCHUNGSMÄHER - BRAZO DESBROZADOR

MOD.		 cm (inch)	 L	 HP	 Kg (Lb)	 Kg (Lb)
BRF 160	28	50 (20")	30	15-25	600 (1322)	230 (507)
BRF 250	28	60 (24")	48	20-30	700 (1543)	260 (573)
BRF 300	40	80 (31")	55	20-30	800 (1763)	300 (661)
BRF 350	40	80 (31")	55	25-35	900 (1984)	350 (772)

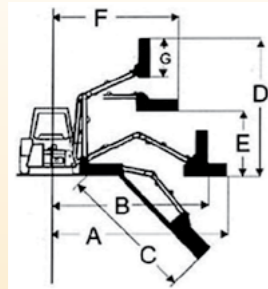

MOD.	A	B	C	D	E	F	G
BRF 160	170 (67")	190 (75")	110 (43")	230 (90")	110 (43")	135 (53")	50 (20")
BRF 250	250 (98")	240 (94")	200 (79")	280 (110")	160 (63")	170 (67")	60 (24")
BRF 300	300 (118")	290 (115")	250 (98")	300 (118")	180 (71")	190 (75")	80 (31")
BRF 350	350 (138")	340 (134")	300 (118")	350 (138")	200 (79")	210 (83")	80 (31")

- 1** Impianto idraulico con pompe in alluminio GR.2 40+13 lt (HP19)  
Hydraulic kit with aluminum pumps GR.2 40+13 lt (HP19)  
Kit hydraulique avec pompes en aluminium GR.2 40+13 lt (HP19)  
Hydraulische Anlage mit Aluminiumpumpen GR.2 40+13 lt (HP19)  
Sistema hidráulico con bombas de aluminio GR.2 40+13 lt (HP19)
- 2** Serbatoio olio autonomo  
Hydraulic reserve oil  
Réservoir huile indépendant  
Unabhängiger Öltank  
Tanque aceite autónomo
- 3** Sistema anti urto sull'attacco a 3 punti  
Anti-shock system on the 3-point hitch  
Système anti choc sur l'attelage à 3 points  
Anfahrerschutzsystem am Dreipunktanbau  
Sistema anti choque en el enganche de 3 puntos
- 4** Rotazione del rotore reversibile  
Reversible rotor direction  
Rotation du rotor réversible  
Reversible Rotordrehung  
Rotación del rotor reversible

**5 STANDARD**

Distributore con cavi flessibili  
Distributor with cables and remote control  
Distributeur avec câbles et commande à distance  
Verteiler mit Fernbedienungskabel  
Distribuidor con cables y mando a distancia

**6 OPTIONAL**

Comandi elettroidraulici con Joystick proporzionale  
Electro-hydraulic control with proportional joystick  
Commande electro-hydraulique avec joystick proport.  
Elektrohydraulische Steuerung mit proport. Joystick  
Mandos electrohidráulicos con joystick proporcional

**7**

Dispositivo flottante sulla testata  
Floating device for flail mower  
Appareil flottant sur la tête  
Vorrichtung für Schwimmstellung des Kopfes  
Dispositivo flotante en la cabeza

## BRV - BRACCIO DECESPUGLIATORE - REACH MOWER - ÉPAREUSE - BÖSCHUNGSMÄHER - BRAZO DESBROZADOR

MOD.		 cm (inch)	 L	 HP	 Kg (Lb)	 Kg (Lb)
BRV 400	36	100 (39")	85	50-60	2100 (4629)	530 (1168)
BRV 450	36	100 (39")	85	50-70	2200 (4850)	570 (1257)

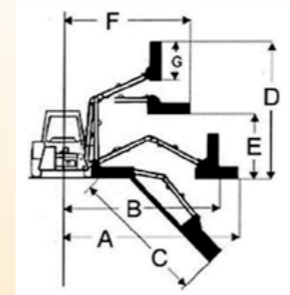

MOD.	A	B	C	D	E	F	G
BRV 400	420 (165")	340 (134")	330 (130")	480 (189")	260 (102")	230 (90")	100 (39")
BRV 450	470 (185")	390 (153")	350 (138")	500 (197")	310 (122")	250 (98")	100 (39")

- 1** Impianto idraulico con pompe in alluminio GR.2 40+13 lt (HP25)  
Hydraulic kit with aluminum pumps GR.2 40+13 lt (HP25)  
Kit hydraulique avec pompes en aluminium GR.2 40+13 lt (HP25)  
Hydraulische Anlage mit Aluminiumpumpen GR.2 40+13 lt (HP25)  
Sistema hidráulico con bombas de aluminio GR.2 40+13 lt (HP25)
- 2** Serbatoio olio autonomo  
Hydraulic reserve oil  
Réservoir huile indépendant  
Unabhängiger Öltank  
Tanque aceite autónomo
- 3** Sistema anti urto sull'attacco a 3 punti  
Anti-shock system on the 3-point hitch  
Système antichoc sur l'attelage à 3 points  
Anfahrerschutzsystem am Dreipunktanbau  
Sistema antichoque enganche de 3 puntos
- 4** Rotazione del rotore reversibile  
Reversible rotor direction  
Rotation du rotor réversible  
Reversible Rotordrehung  
Rotación del rotor reversible

**5 STANDARD**

Distributore con cavi flessibili  
Distributor with cables and remote control  
Distributeur avec câbles et commande à distance  
Verteiler mit Fernbedienungskabel  
Distribuidor con cables y mando a distancia

**6 OPTIONAL**

Comandi elettroidraulici con Joystick proporzionale  
Electro-hydraulic control with proportional joystick  
Commande electro-hydraulique avec joystick proport.  
Elektrohydraulische Steuerung mit proport. Joystick  
Mandos electrohidráulicos con joystick proporcional

**7**

Dispositivo flottante sulla testata  
Floating device for flail mower  
Appareil flottant sur la tête  
Vorrichtung für Schwimmstellung des Kopfes  
Dispositivo flotante en la cabeza



OPTIONAL

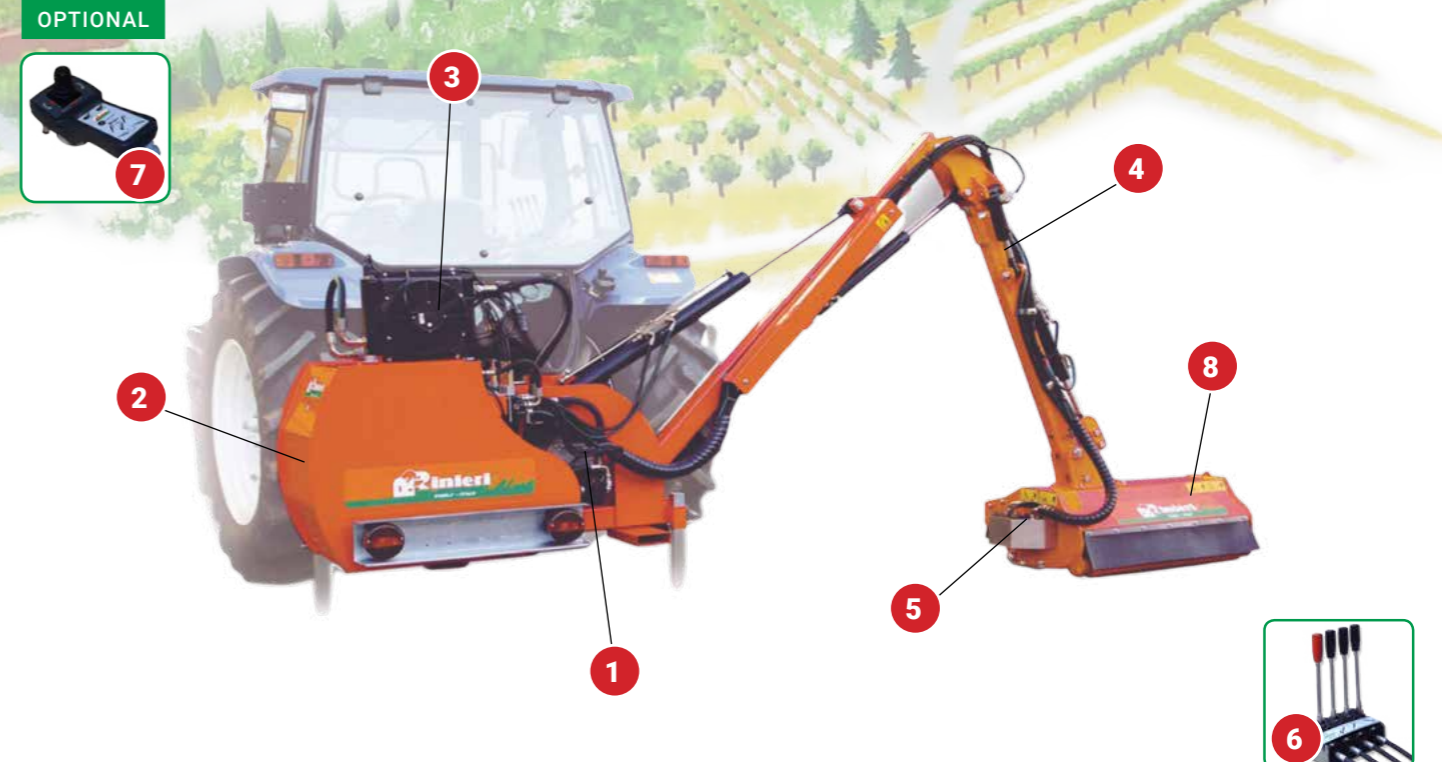

OPTIONAL



**BR VIGNA - BRACCIO DECESPUGLIATORE - REACH MOWER - ÉPAREUSE - BÖSCHUNGSMÄHER - BRAZO DESBROZADOR**

MOD.					
		cm (inch)	L	HP	Kg (Lb)
BR VIGNA	28	80 (31")	95	50-70	2200 (4850)
BR VIGNA PLUS	28	80 (31")	95	50-70	2200 (4850)

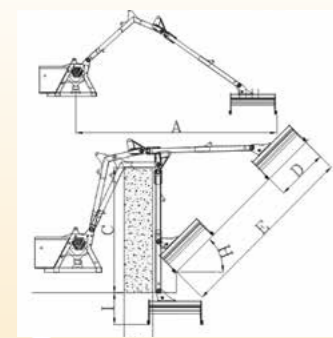

MOD.	A	B	C	D	E	H	I
BR VIGNA	415 (163")	60 (24")	220 (87")	80 (31")	320 (126")	45°	30 (11")
BR VIGNA PLUS	470 (185")	60 (24")	250 (98")	80 (31")	380 (149")	45°	37 (14")

- 1** Impianto idraulico con pompe in alluminio GR.2 40+13 lt (HP25)  
Hydraulic kit with aluminum pumps GR.2 40+13 lt (HP25)  
Kit hydraulique avec pompes en aluminium GR.2 40+13 lt (HP25)  
Hydraulische Anlage mit Aluminiumpumpen GR.2 40+13 lt (HP25)  
Sistema hidráulico con bombas de aluminio GR.2 40+13 lt (HP25)
- 2** Serbatoio olio autonomo  
Hydraulic reserve oil  
Réservoir huile indépendant  
Unabhängiger Öltank  
Tanque aceite autónomo
- 3** Radiatore raffreddamento olio  
Oil cooler  
Radiateur refroidissement huile  
Ölkühler  
Radiador de refrigeración de aceite
- 4** Braccio telescopico  
Telescopic arm  
Bras telescopique  
Teleskoparm  
Brazo telescópico
- 5** Dispositivo antiurto idr.  
Hydraulic shockproof device  
Dispositif anti choc hydr.  
Hydraulischer Anfahrerschutz  
Dispositivo antichoque hidr.

- 6** Rotazione del rotore reversibile  
Reversible rotor direction  
Rotation du rotor réversible  
Reversible Rotordrehung  
Rotación del rotor reversible
- 7 STANDARD** Distributore con cavi flessibili  
Distributor with cables and remote control  
Distributeur avec câbles et commande à distance  
Verteiler mit Fernbedienungskabel  
Distribuidor con cables y mando a distancia
- 8 OPTIONAL** Comandi elettroidraulici con Joystick proporzionale  
Electro-hydraulic control with proportional joystick  
Commande electro-hydraulique avec joystick proport.  
Elektrohydraulische Steuerung mit proport. Joystick  
Mandos electrohidráulicos con joystick proporcional
- 9** Dispositivo flottante sulla testata  
Floating device for flail mower  
Appareil flottant sur la tête  
Vorrichtung für Schwimmstellung des Kopfes  
Dispositivo flotante en la cabeza

**BRC - BRACCIO DECESPUGLIATORE - REACH MOWER - ÉPAREUSE - BÖSCHUNGSMÄHER - BRAZO DESBROZADOR**

MOD.					
		cm (inch)	L	HP	Kg (Lb)
BRC 450	32 + 16	100 (39")	190	60-70	2500 (5511)
BRC 485	32 + 16	100 (39")	200	60-80	2800 (6172)
BRC 530	32 + 16	100 (39")	200	70-90	3200 (7054)

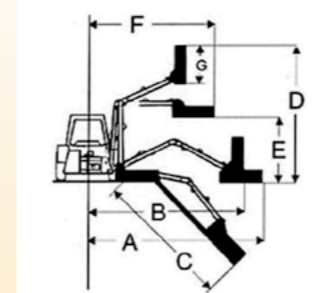

MOD.	A	B	C	D	E	F	G
BRC 450	450 (177")	380 (150")	350 (138")	390 (153")	240 (94")	240 (94")	100 (39")
BRC 485	485 (191")	415 (163")	385 (151")	425 (167")	250 (98")	245 (96")	100 (39")
BRC 530	530 (209")	460 (180")	430 (169")	470 (185")	265 (104")	260 (102")	100 (39")

- 1** Impianto idraulico con pompe in alluminio GR.3 80+30 lt (HP45)  
Hydraulic kit with aluminum pumps GR.3 80+30 lt (HP45)  
Kit hydraulique avec pompes en aluminium GR.3 80+30 lt (HP45)  
Hydraulische Anlage mit Aluminiumpumpen GR.3 80+30 lt (HP45)  
Sistema hidráulico con bombas de aluminio GR.3 80+30 lt (HP45)
- 2** Serbatoio olio autonomo  
Hydraulic reserve oil  
Réservoir huile indépendant  
Unabhängiger Öltank  
Tanque aceite autónomo
- 3** Radiatore raffreddamento olio  
Oil cooler  
Radiateur refroidissement huile  
Ölkühler  
Radiador de refrigeración de aceite
- 4** Dispositivo antiurto idraulico  
Hydraulic shockproof device  
Dispositif anti choc hydraulique  
Hydraulischer Anfahrerschutz  
Dispositivo antichoque hidráulico

- 5** Rotazione del rotore reversibile  
Reversible rotor direction  
Rotation du rotor réversible  
Reversible Rotordrehung  
Rotación del rotor reversible
- 6 STANDARD** Distributore con cavi flessibili  
Distributor with cables and remote control  
Distributeur avec câbles et commande à distance  
Verteiler mit Fernbedienungskabel  
Distribuidor con cables y mando a distancia
- 7 OPTIONAL** Comandi elettroidraulici con Joystick proporzionale  
Electro-hydraulic control with proportional joystick  
Commande electro-hydraulique avec joystick proport.  
Elektrohydraulische Steuerung mit proport. Joystick  
Mandos electrohidráulicos con joystick proporcional
- 8** Dispositivo flottante sulla testata  
Floating device for flail mower  
Appareil flottant sur la tête  
Vorrichtung für Schwimmstellung des Kopfes  
Dispositivo flotante en la cabeza

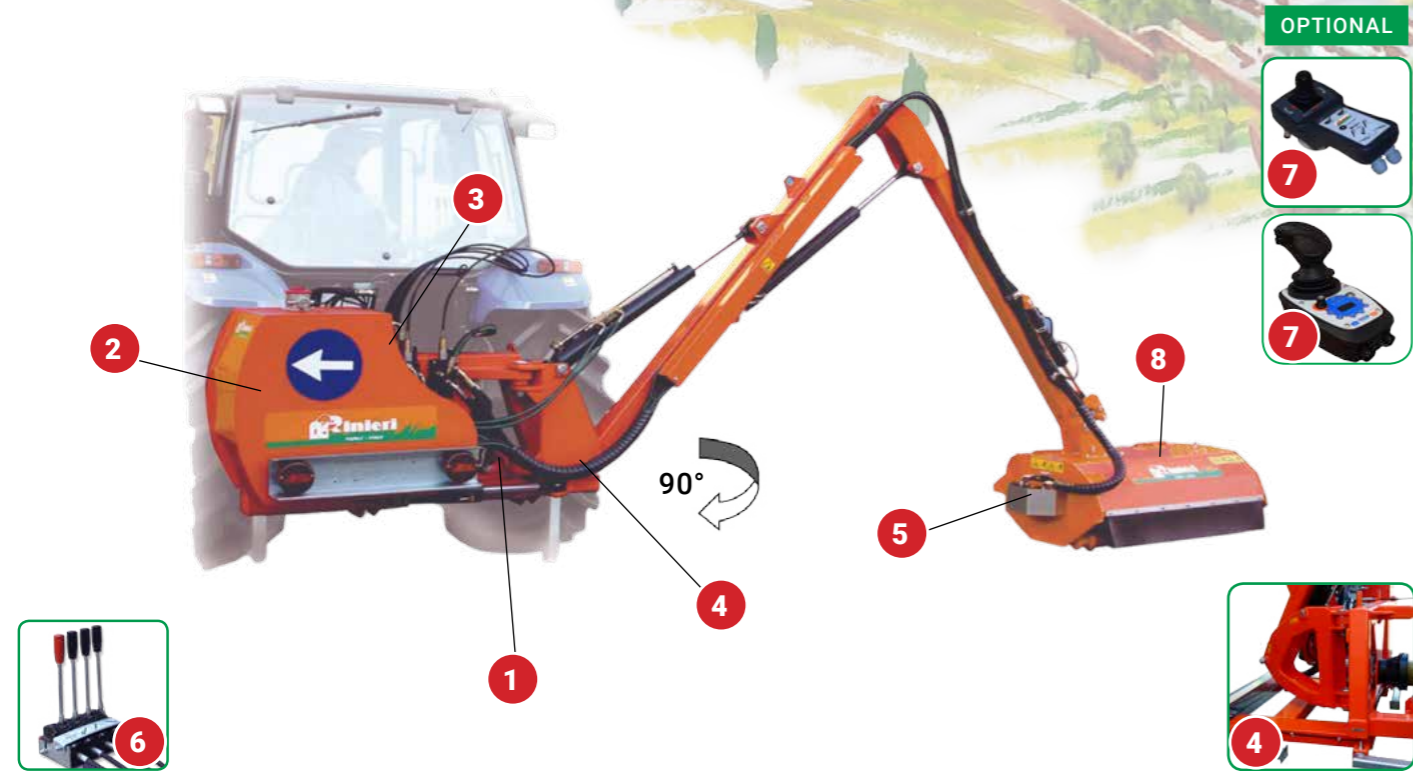

OPTIONAL



BRL - BRACCIO DECESPUGLIATORE - REACH MOWER - ÉPAREUSE - BÖSCHUNGSMÄHER - BRAZO DESBROZADOR

MOD.						
	cm (inch)	L	HP	Kg (Lb)	Kg (Lb)	
BRL 500	32 + 16	100 (39")	200	70-90	3000 (6613)	850 (1874)
BRL 600	40 + 20	120 (47")	205	90-110	4300 (9479)	1060 (2337)

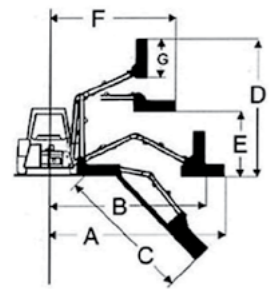

MOD.	A	B	C	D	E	F	G
BRL 500	510 (201")	450 (177")	420 (165")	470 (185")	240 (94")	300 (118")	100 (39")
BRL 600	620 (244")	530 (209")	520 (205")	570 (224")	255 (100")	390 (153")	120 (47")

- 1** Impianto idraulico con pompe in alluminio GR.3 80+30 lt (HP45)  
Hydraulic kit with aluminum pumps GR.3 80+30 lt (HP45)  
Kit hydraulique avec pompes en aluminium GR.3 80+30 lt (HP45)  
Hydraulische Anlage mit Aluminiumpumpen GR.3 80+30 lt (HP45)  
Sistema hidráulico con bombas de aluminio GR.3 80+30 lt (HP45)
- 2** Serbatoio olio autonomo  
Hydraulic reserve oil  
Réservoir huile indépendant  
Unabhängiger Öltank  
Tanque aceite autónomo
- 3** Radiatore raffreddamento olio  
Oil cooler  
Radiateur refroidissement huile  
Ölkühler  
Radiador de refrigeración de aceite
- 4** Rotazione 1° braccio con antiurto idraul.  
1° arm rotation with hydr. shockproof  
Rotation du 1° bras avec antichoc hydr.  
erste Arm Drehung mit hydr. Stoßdämpfer  
Rotación 1° brazo con antichoque hidr.

- 5** Rotazione del rotore reversibile  
Reversible rotor direction  
Rotation du rotor réversible  
Reversible Rotordrehung  
Rotación del rotor reversible
- 6 STANDARD** Distributore con cavi flessibili  
Distributor with cables and remote control  
Distributeur avec câbles et commande à distance  
Verteiler mit Fernbedienungskabel  
Distribuidor con cables y mando a distancia
- 7 OPTIONAL** Comandi elettroidraulici con Joystick proporzionale  
Electro-hydraulic control with proportional joystick  
Commande electro-hydraulique avec joystick proport.  
Elektrohydraulische Steuerung mit proport. Joystick  
Mandos electrohidráulicos con joystick proporcional
- 8** Dispositivo flottante sulla testata  
Floating device for flail mower  
Appareil flottant sur la tête  
Vorrichtung für Schwimmstellung des Kopfes  
Dispositivo flotante en la cabeza



OPTIONAL

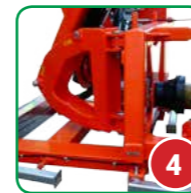

BRT - BRACCIO DECESPUGLIATORE - REACH MOWER - ÉPAREUSE - BÖSCHUNGSMÄHER - BRAZO DESBROZADOR

MOD.						
	cm (inch)	L	HP	Kg (Lb)	Kg (Lb)	
BRT 660	40 + 20	120 (47")	210	100 - 120	5000 (11023)	1220 (2690)

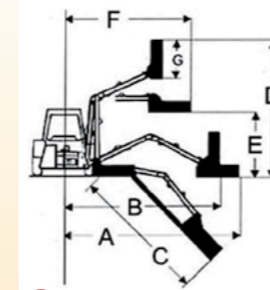

MOD.	A	B	C	D	E	F	G
BRT 660	660 (260")	590 (232")	570 (224")	660 (260")	255 (100")	410 (161")	120 (47")

- 1** Impianto idra. con pompe in ghisa GR.3 95+30 lt (HP60)  
Hydraulic kit with iron pumps GR.3 95+30 lt (HP60)  
Kit hydraul. avec pompes en fonte GR.3 95+30 lt (HP60)  
Hydr. Anlage mit Gusseisenpumpen GR.3 95+30lt (HP60)  
Sistema hidr. con bombas de hierro fundido GR.3 95+30 lt (HP60)
- 2** Serbatoio olio autonomo  
Hydraulic reserve oil  
Réservoir huile indépendant  
Unabhängiger Öltank  
Tanque aceite autónomo
- 3** Radiatore raffreddamento olio  
Oil cooler  
Radiateur refroidissement huile  
Ölkühler  
Radiador de refrigeración de aceite
- 4** Rotazione 1° braccio con antiurto idraul.  
1° arm rotation with hydr. shockproof  
Rotation du 1° bras avec antichoc hydr.  
Erste Arm Drehung mit hydr. Stoßdämpfer  
Rotación 1° brazo con antichoque hidr.
- 5** Braccio telescopico  
Telescopic arm  
Bras telescopique  
Teleskoparm  
Brazo telescópico

- 6** Rotazione del rotore reversibile  
Reversible rotor direction  
Rotation du rotor réversible  
Reversible Rotordrehung  
Rotación del rotor reversible
- 7 STANDARD** Distributore con cavi flessibili  
Distributor with cables and remote control  
Distributeur avec câbles et commande à distance  
Verteiler mit Fernbedienungskabel  
Distribuidor con cables y mando a distancia
- 8 OPTIONAL** Comandi elettroidraulici con Joystick proporzionale  
Electro-hydraulic control with proportional joystick  
Commande electro-hydraulique avec joystick proport.  
Elektrohydraulische Steuerung mit proport. Joystick  
Mandos electrohidráulicos con joystick proporcional
- 9** Dispositivo flottante sulla testata  
Floating device for flail mower  
Appareil flottant sur la tête  
Vorrichtung für Schwimmstellung des Kopfes  
Dispositivo flotante en la cabeza

OPTIONAL



BR-VISION - BRACCIO DECESPUGLIATORE - REACH MOWER - ÉPAREUSE - BÖSCHUNGSMÄHER - BRAZO DESBROZADOR

MOD.						
	cm (inch)	L	HP	Kg (Lb)	Kg (Lb)	
BR-VISION 490	32 + 16	100 (39")	190	70-90	3000 (6613)	850 (1874)
BR-VISION 550	32 + 16	100 (39")	200	90-100	4200 (9259)	1160 (2557)

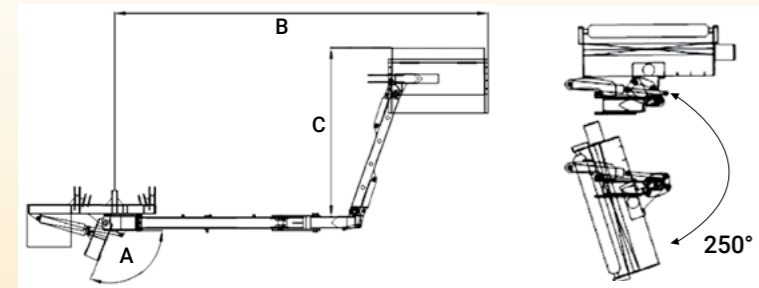

MOD.	A	B	C
BR VISION 490	115°	490 (193")	156 (61")
BR VISION 550	122°	550 (216")	156 (61")

- 1** Impianto idraulico con pompe in alluminio GR.3 80+30 lt (HP60)  
Hydraulic kit with aluminum pumps GR.3 80+30 lt (HP60)  
Kit hydraulique avec pompes en aluminium GR.3 80+30 lt (HP60)  
Hydraulische Anlage mit Aluminiumpumpen GR.3 80+30 lt (HP60)  
Sistema hidráulico con bombas de aluminio GR.3 80+30 lt (HP60)
- 2** Serbatoio olio autonomo  
Hydraulic reserve oil  
Réservoir huile indépendant  
Unabhängiger Öltank  
Tanque aceite autónomo
- 3** Radiatore raffreddamento olio  
Oil cooler  
Radiateur refroidissement huile  
Ölkühler  
Radiador de refrigeración de aceite
- 4** Rotazione 1° braccio con antiurto idraul.  
1° arm rotation with hydr. shockproof  
Rotation du 1° bras avec antichoc hydr.  
Erste Arm Drehung mit hydr. Stoßdämpfer  
Rotación 1° brazo con antichoque hidrául.
- 5** Rotazione del rotore reversibile  
Reversible rotor direction  
Rotation du rotor réversible  
Reversible Rotordrehung  
Rotación del rotor reversible
- 6 STANDARD** Distributore con cavi flessibili  
Distributor with cables and remote control  
Distributeur avec câbles et commande à distance  
Verteiler mit Fernbedienungskabel  
Distribuidor con cables y mando a distancia
- 7 OPTIONAL** Comandi elettroidraulici con Joystick proporzionale  
Electro-hydraulic control with proportional joystick  
Commande electro-hydraulique avec joystick proport.  
Elektrohydraulische Steuerung mit proport. Joystick  
Mandos electrohidráulicos con joystick proporcional
- 8** Dispositivo flottante sulla testata  
Floating device for flail mower  
Appareil flottant sur la tête  
Vorrichtung für Schwimmstellung des Kopfes  
Dispositivo flotante en la cabeza



APERTURA MASSIMA 550CM - MAXIMUM OPENING 550CM - OUVERTURE MAXIMALE 550CM - MAXIMALE ÖFFNUNG 550CM - APERTURA MÁXIMA 550CM



VISIONE LATERALE DELLA TESTATA - SIDE VIEW OF THE HEAD - VUE LATÉRALE DE LA TÊTE - SEITENANSICHT DES KOPFES - VISTA LATERAL DEL CABEZAL  
CHIUSURA PER TRASPORTO - TRANSPORT CLOSURE - FERMETURE DE TRANSPORT - TRANSPORTVERSCHLUSS - CIERRE DE TRANSPORTE



## TESTATE BRACCI DECESPUGLIATORI REACH MOWERS HEADS TÊTES ÉPAREUSES BÖSCHUNGSMÄHER CABEZALES DESBROZADORES

	MOD.						
		N°	Cm / Inch	L/min	Kg / Libr	Cm / Inch	
TLB060	BRF	28	60 - 23"	45	45 - 99	2 - 0,8"	
TLB080	BRF	40	80 - 31"	45	50 - 110	2 - 0,8"	
TL080	BRV BR VIGNA	28	80 - 31"	45	130 - 286	2 - 0,8"	
TL100	BRV	36	100 - 39"	45	140 - 308	2 - 0,8"	
TP100	BRC	32+16	100 - 39"	80	175 - 385	3 - 1,1"	
TP120	BRC	40+20	120 - 47"	80	190 - 418	3 - 1,1"	
TPX100	BRL BR VISION	32+16	100 - 39"	80	195 - 429	4 - 1,5"	
TPX120	BRL - BRT	40+20	120 - 47"	80	220 - 440	4 - 1,5"	

# OPTIONAL

MOD		Misure Measures			Applicable Installabile	
		cm (inch)				cm (inch)
	BT 120/020	2 (0,8")	120 (47")	12	45 (99)	BRF - BRV
	BT 150/030	3 (1,2")	150 (59")	20	50 (110)	BRF - BRV
	BT 180/030	3 (1,2")	180 (71")	20	55 (121)	BRF - BRV
	BT 200/030	3 (1,2")	200 (79")	25	60 (132)	BRF - BRV
	BT 120/020 B	2 (0,8")	120 (47")	10	45 (99)	BRF
	BT 150/030 B	2 (0,8")	150 (59")	15	50 (110)	BRF
	BT 180/030 B	2 (0,8")	180 (71")	15	55 (121)	BRF
	BT 200/030 B	2 (0,8")	200 (79")	15	60 (132)	BRF
	BT 150/050	5 (2")	150 (59")	80	145 (320)	BRC
	BT 180/050	5 (2")	180 (71")	80	155 (342)	BRC
	BT 210/050	5 (2")	210 (83")	80	170 (375)	BRC
	BTX 150/100	10 (3,9")	150 (59")	80	215 (474)	BRL - BRT
	BTX 190/100	10 (3,9")	190 (75")	80	235 (518)	BRL - BRT
	BTX 220/100	10 (3,9")	220 (87")	80	250 (551)	BRL - BRT

# OPTIONAL

MOD		Misure Measures			Applicable Installabile	
		A cm (inch)				Kg (lbs)
	TDL 100	6 (2,3")	100 (39")	40 (88)	3	BRV
	TDL 140	6 (2,3")	140 (55")	50 (110)	4	BRV
	TD 120	8 (3,1")	120 (47")	115 (250)	2	BRC - BRL - BRT
	TD 170	8 (3,1")	170 (67")	155 (342)	3	BRC - BRL - BRT
	TD 220	8 (3,1")	220 (87")	195 (430)	4	BRC - BRL - BRT
	TD 270	8 (3,1")	270 (106")	240 (529)	5	BRC - BRL - BRT
	MOWER DECK	3 (1,2")	100 (39")	105 (231)		BRF



# Rinieri!

*Tradizione*

*Famiglia*

*Lavoro*

*Innovazione*

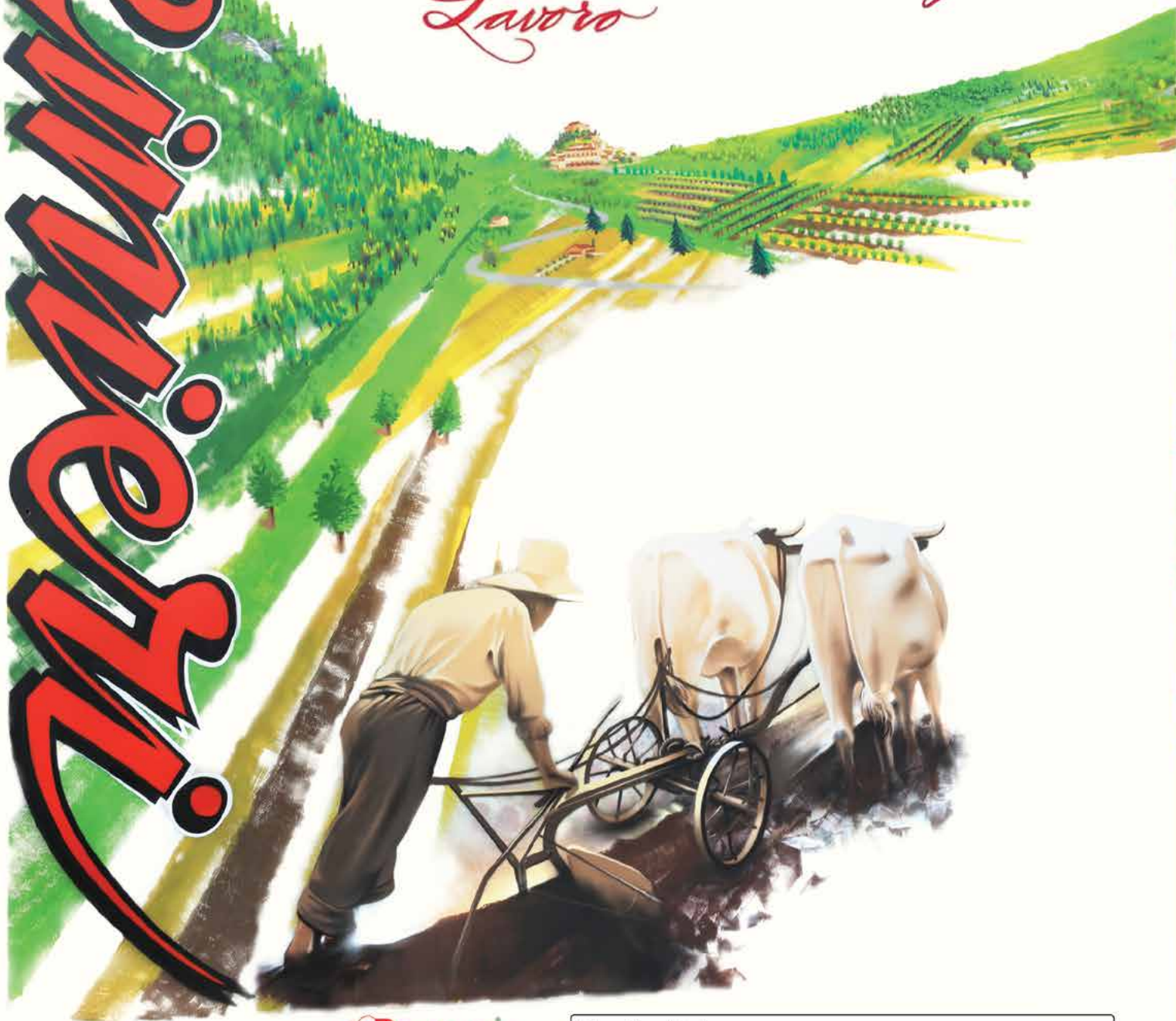

Via dell'Appennino 606B - 47121 - Forlì (FC) - ITALY  
Tel. +39 0543 86066 - info@rinieri.com

[www.rinieri.com](http://www.rinieri.com)



La Ditta si riserva di apportare alle macchine tutte le modifiche che riterrà più opportune.  
The manufacturer reserves the right to modify the machines as necessary.

Rivenditore/dealer